



Kurbelwelle  
Crankshaft  
Vilebrequin  
Ciguenal

Referenznr.:

0150-05-0510 2066

003 ©

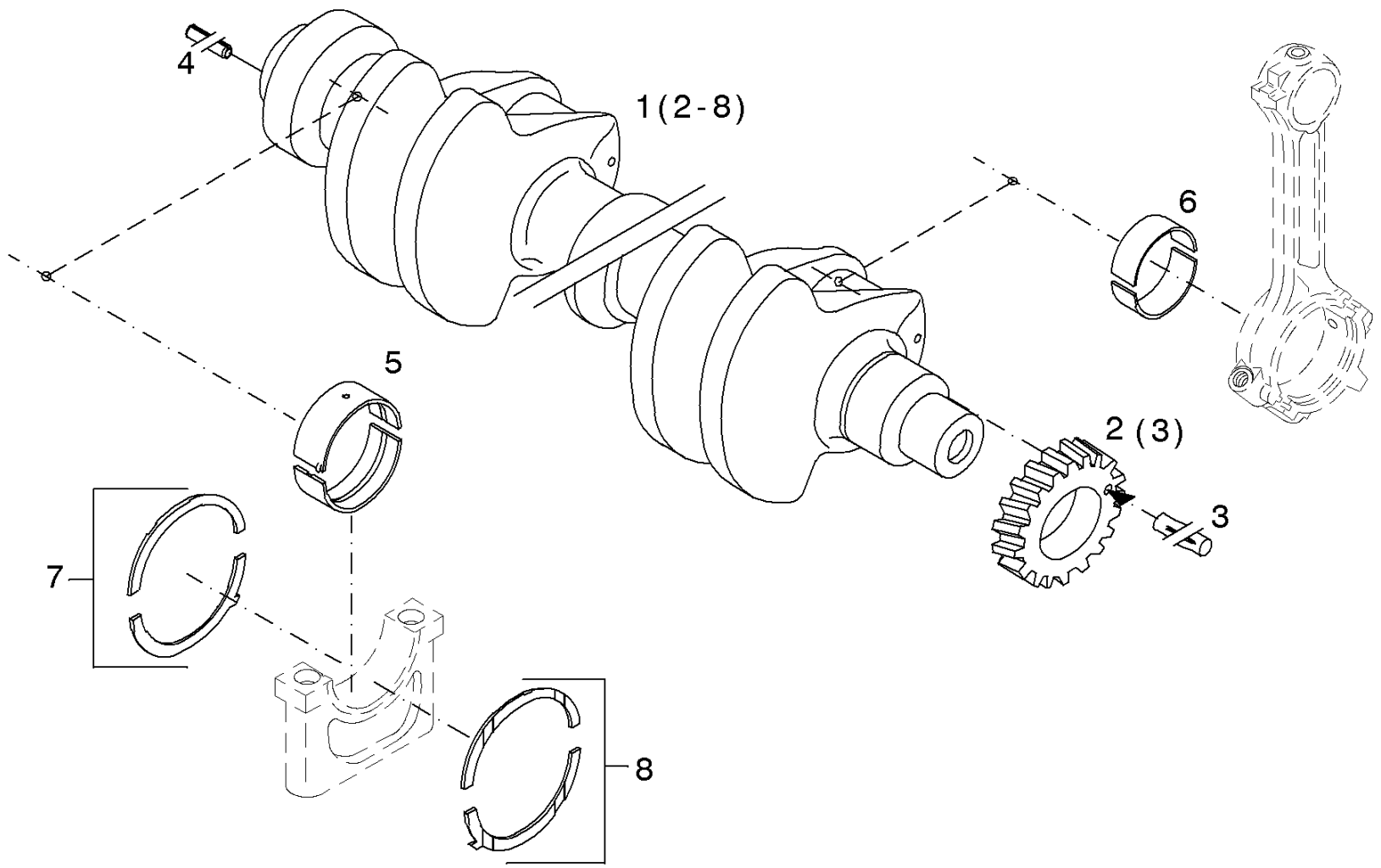
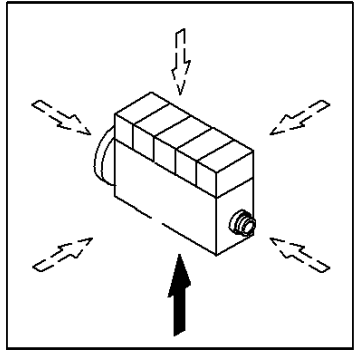



Keilriemenscheibenanbau  
V-belt pulley assembly  
Montage de poulie à gorge trapezoidale  
Montaje de polea trapecial

Referenznr.:

0150-05- 0510 2067

003 ©

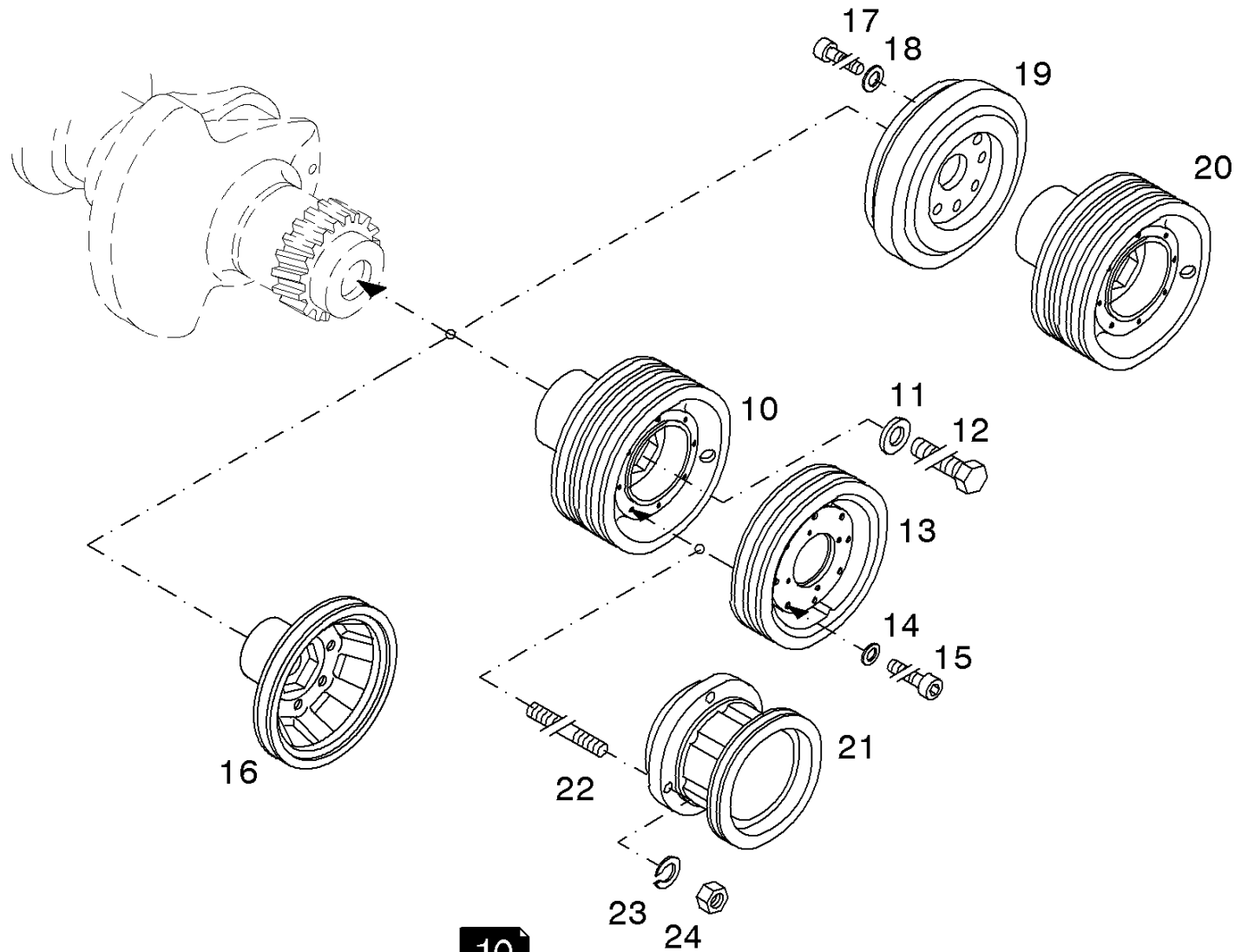
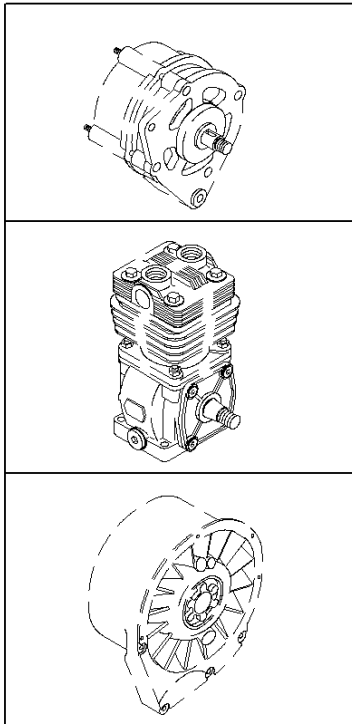
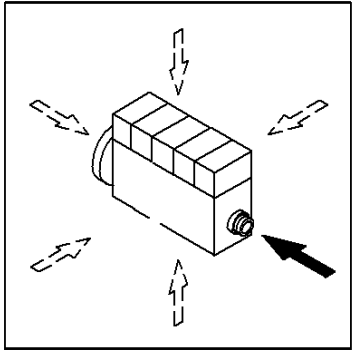



Schwungrad  
Flywheel  
Volant  
Volante

Referenznr.:

0150-05-0510 2068

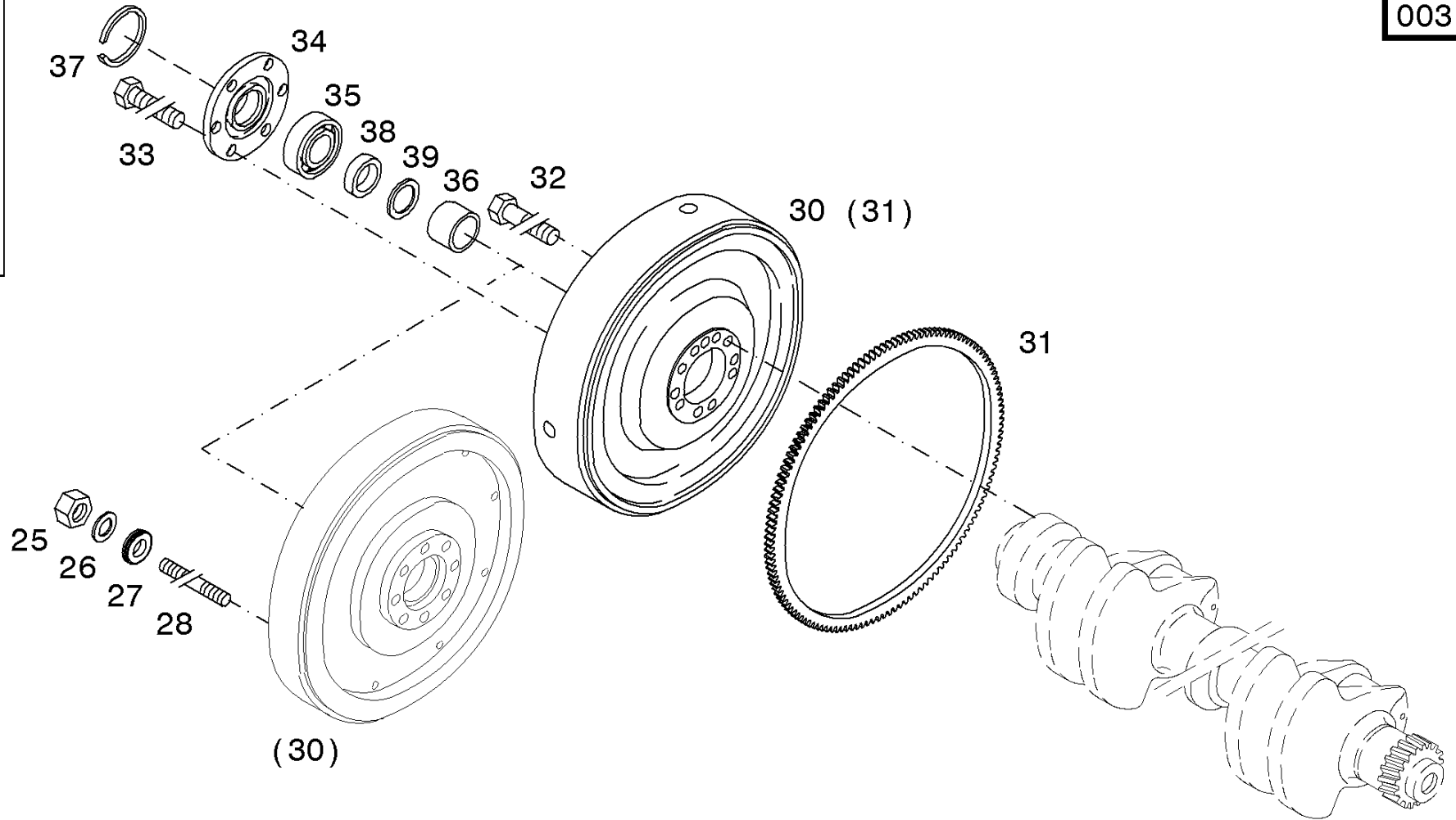
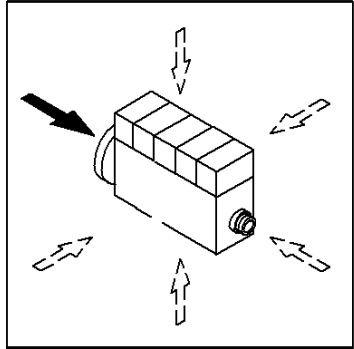

003 ©



Massenausgleichsgetriebe  
Dynamic balancer  
Equilibreur dynamique  
Equilibrador masa

Referenznr.:

0150-05-0510 2088

003 ©

