

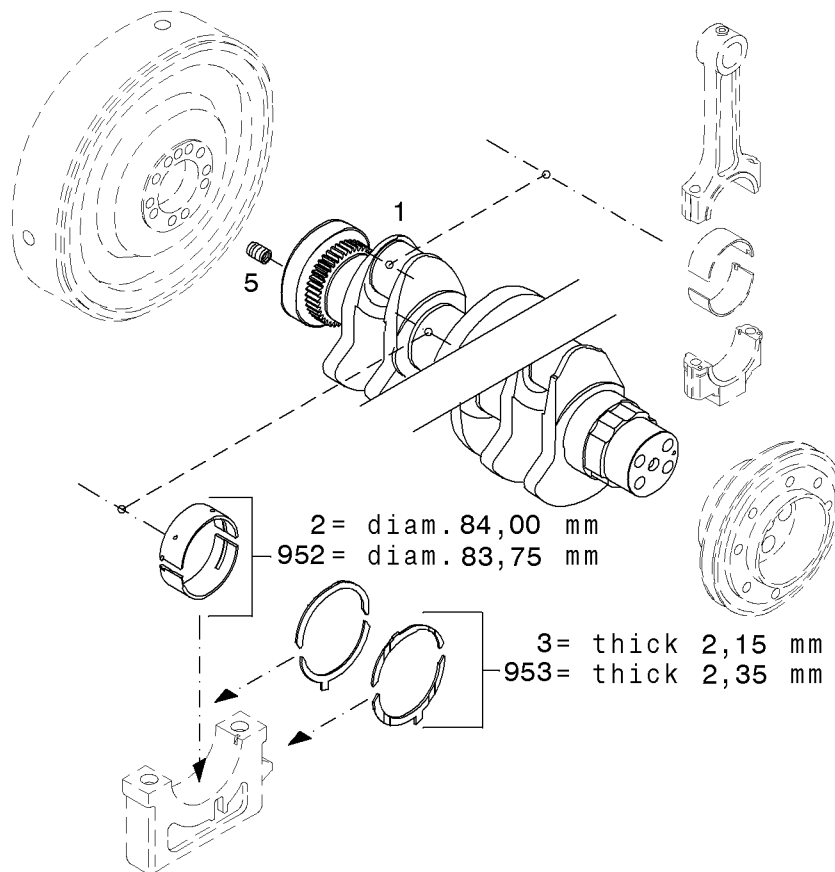

Kurbelwelle
Crankshaft
Vilebrequin
Ciguenal

Referenznr.:

0128-05-0510 2560

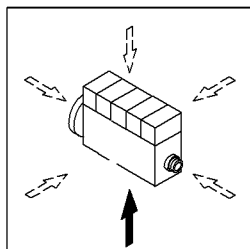

001 ©



Keilriemenscheibenanbau
V-belt pulley assembly
Montage de poulie à gorge trapezoidale
Montaje de polea trapecial

Referenznr.:

0128-05-0510 2561

002 ©

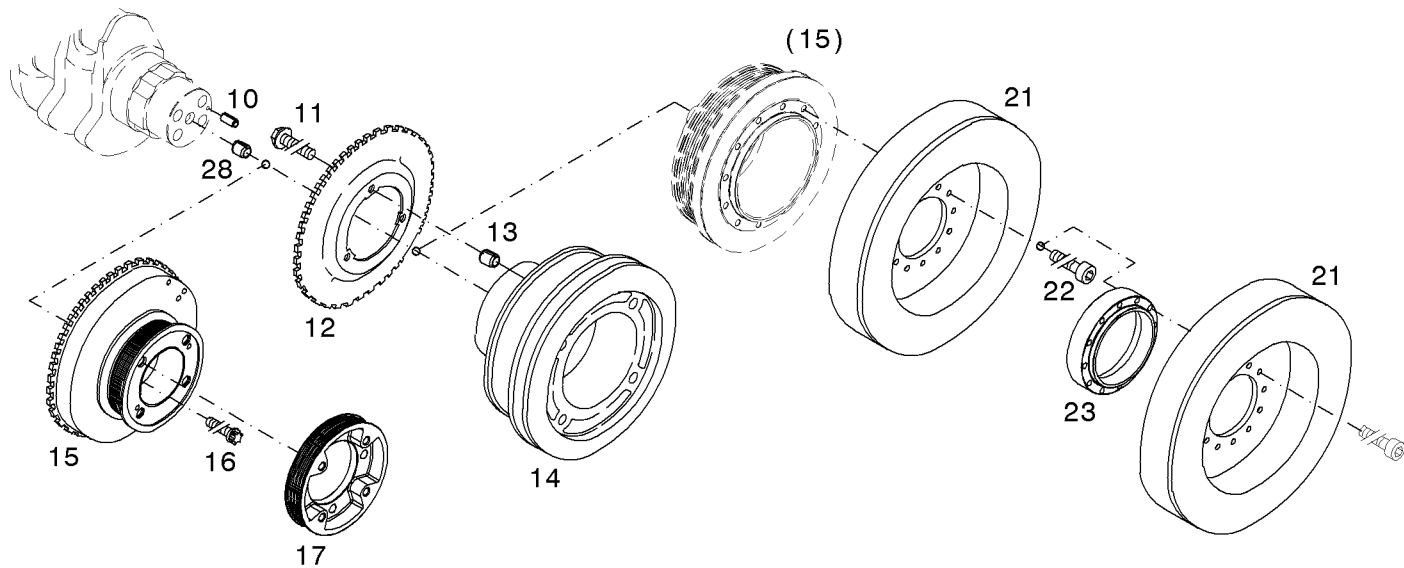
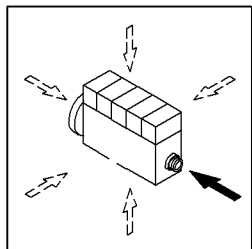



Schwungrad
Flywheel
Volant
Volante

Referenznr.:

0128-05-0510 2562

001 ©

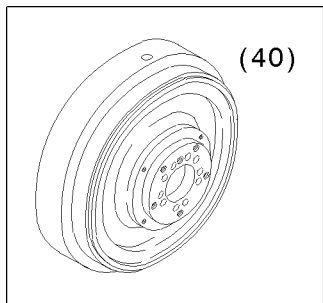
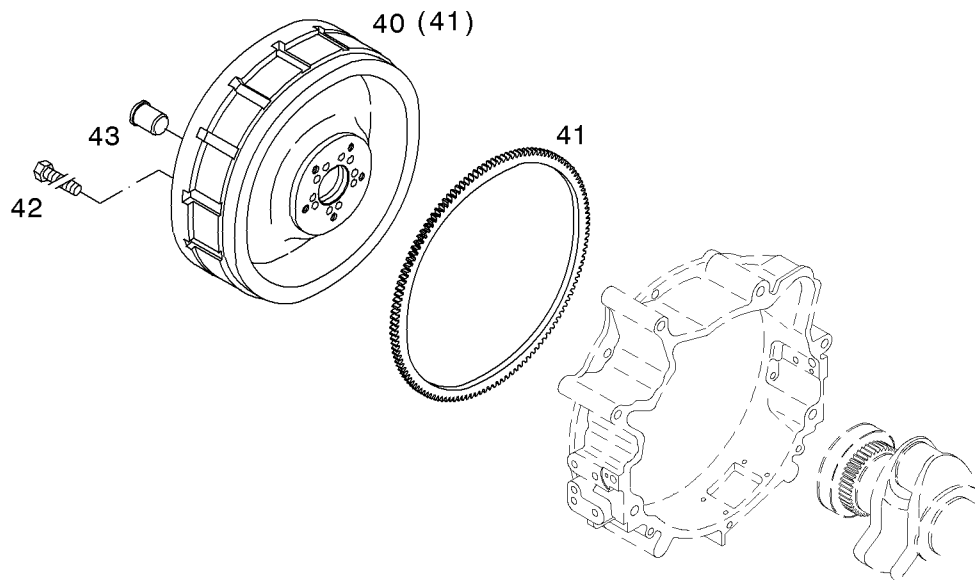
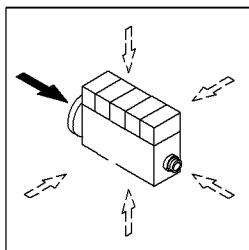



Massenausgleichsgetriebe
Dynamic balancer
Equilibreur dynamique
Equilibrador masa

Referenznr.:

0128-05-0510 2563

001 ©

