



Zylinderkopf
Cylinder head
Culasse
Culata

Referenznr.:

0128-08-0510 2418

004 ©

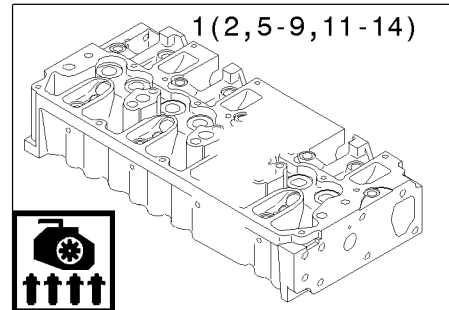
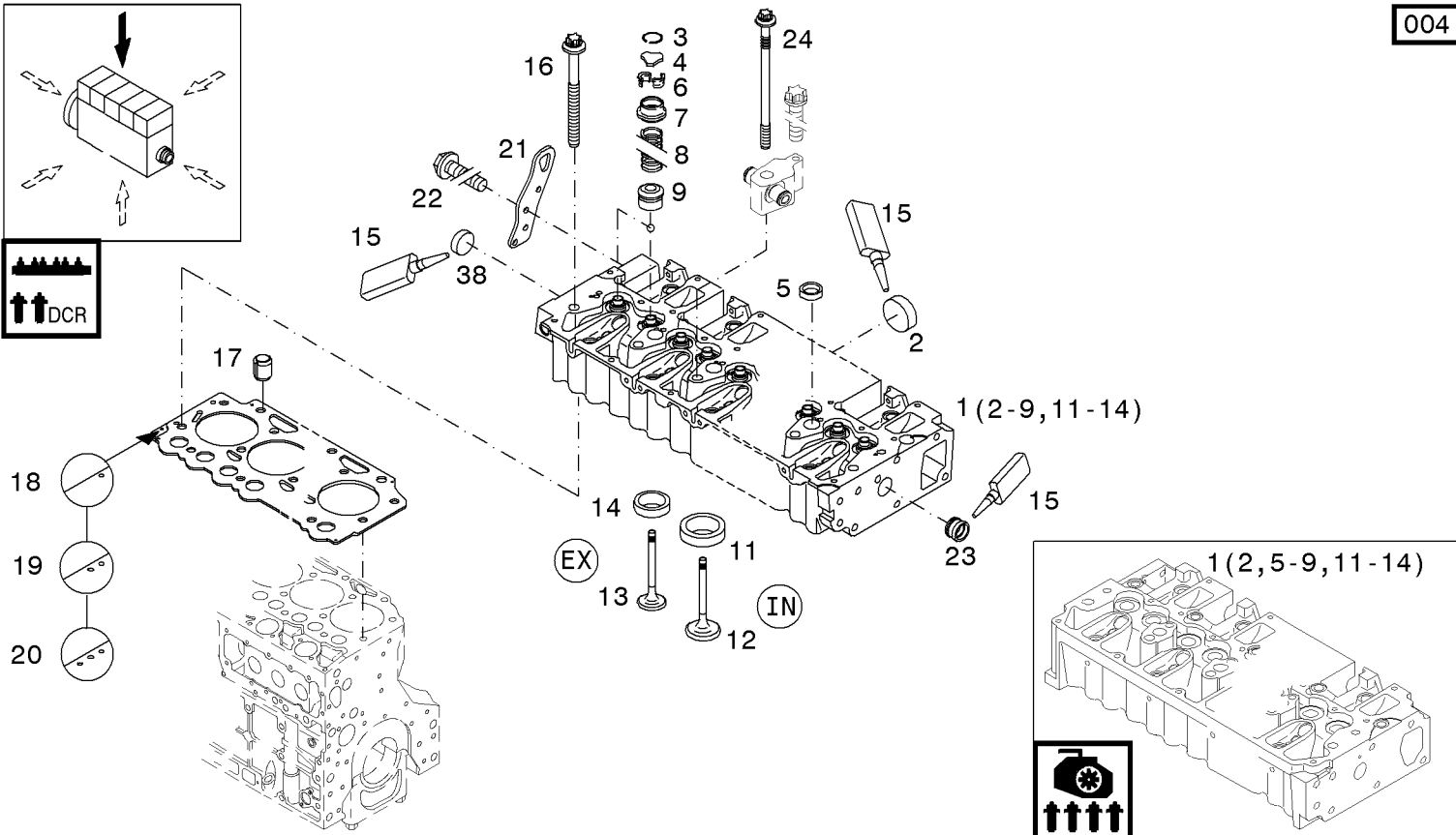
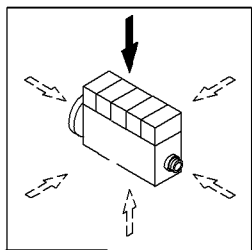



Ventilantriebshaube
Valve mechanism cover
Capot de culbuteur
Tapa de balancines

Referenznr.:

0128-08-0510 2419

