

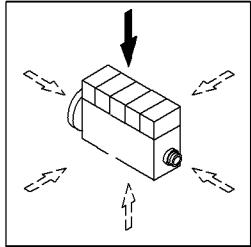

Zylinderkopf  
Cylinder head  
Culasse  
Culata

Referenznr.:

0128-08-0510 2251



003 ©

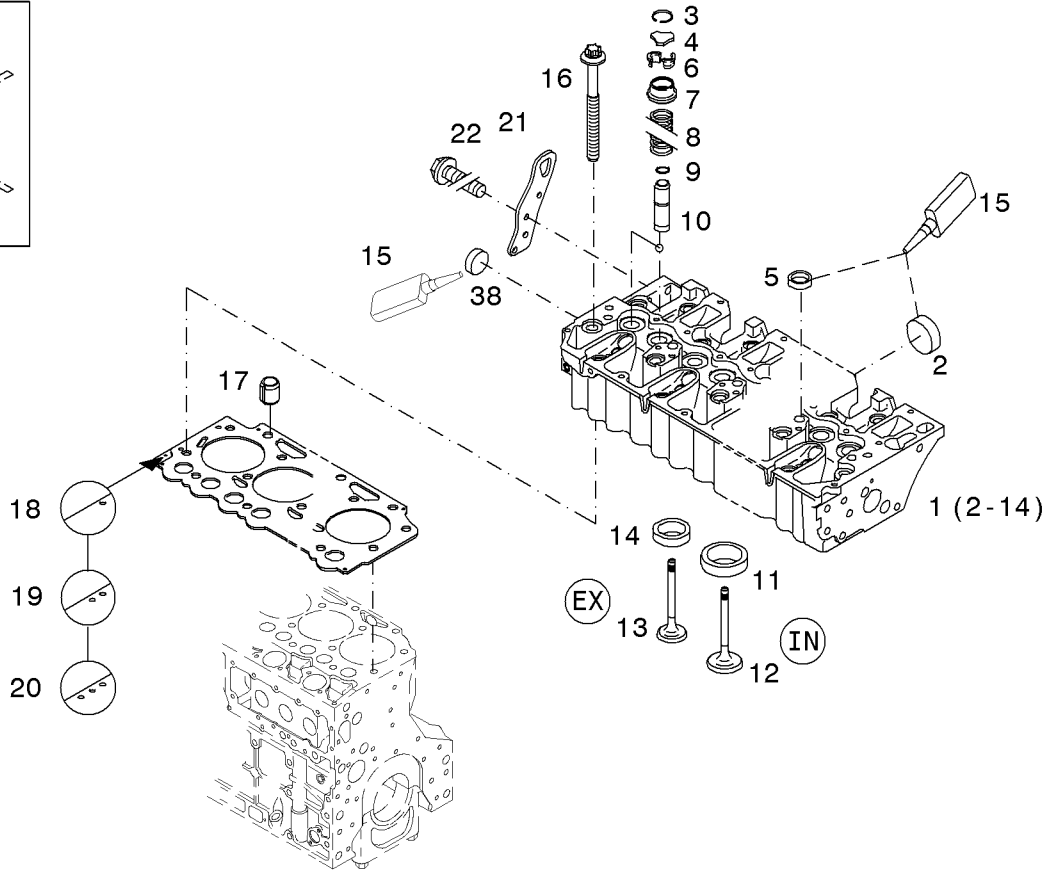



Ventilantriebshaube  
Valve mechanism cover  
Capot de culbuteur  
Tapa de balancines

Referenznr.:

0128-08-0510 2252

