

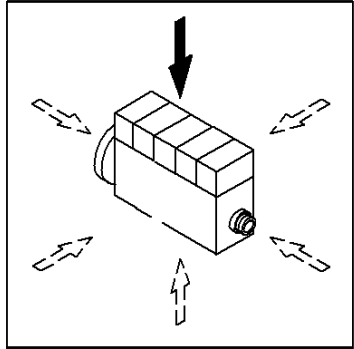

Einspritzventil
Fuel injector
Porte-injecteur de combustible complet
Injector

Referenznr.:

0150-19- 0510 2083



004 ©

