

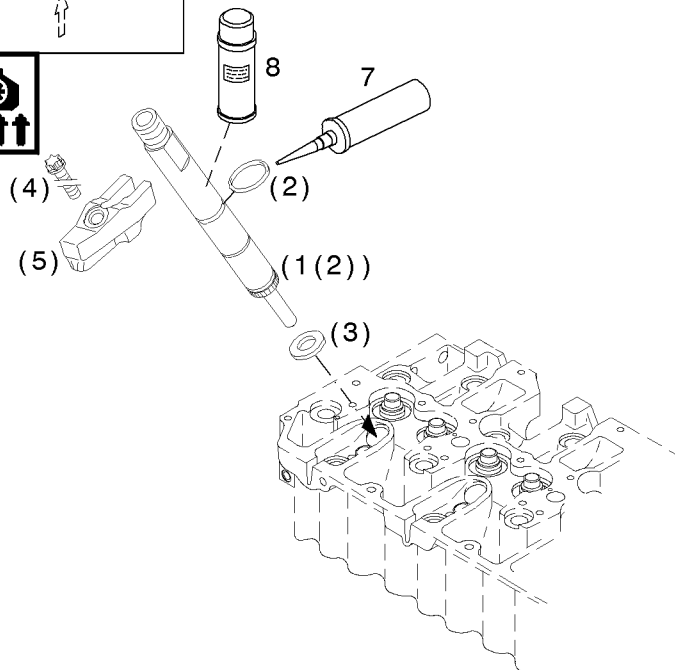

Einspritzventil
Fuel injector
Porte-injecteur de combustible complet
Injector

Referenznr.:

0128-19-0510 2260

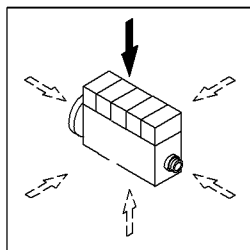

004 ©

