

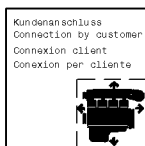

Kabelbaum
Cable harness
Faisceau de cables
Haz de cables

Referenznr.:

0128-**48**- 0510 2591

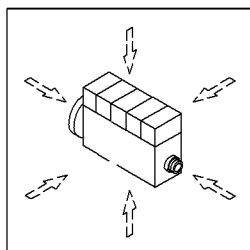

002 ©

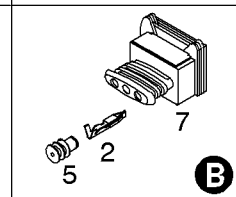
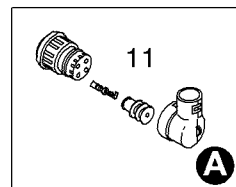
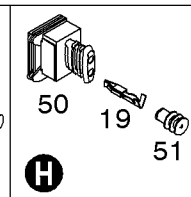
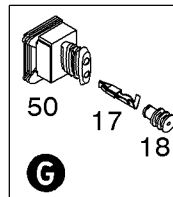
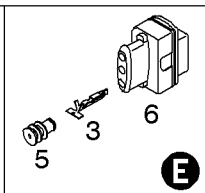
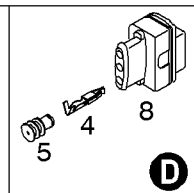
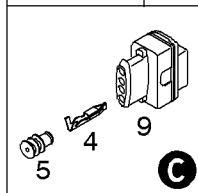
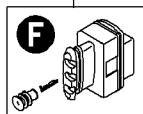
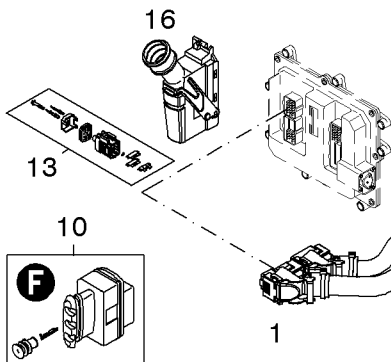
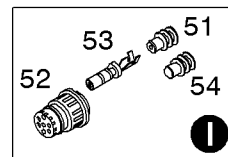



Kabelbaum
 Cable harness
 Faisceau de cables
 Haz de cables

Referenznr.:

0128-48-0510 2605

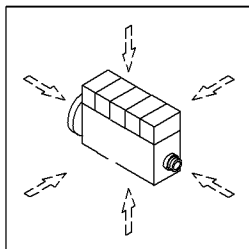

Kundenanschluss
 Connection by customer
 Connexion client
 Conexión per cliente



001 ©

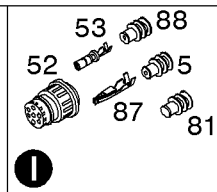
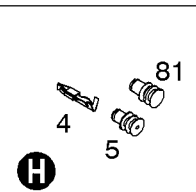
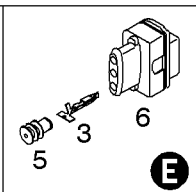
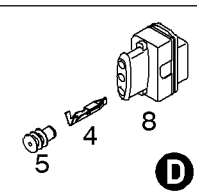
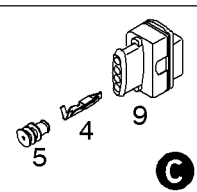
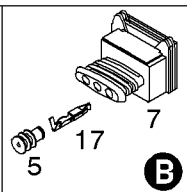
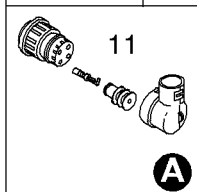
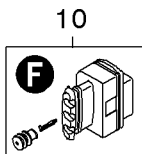
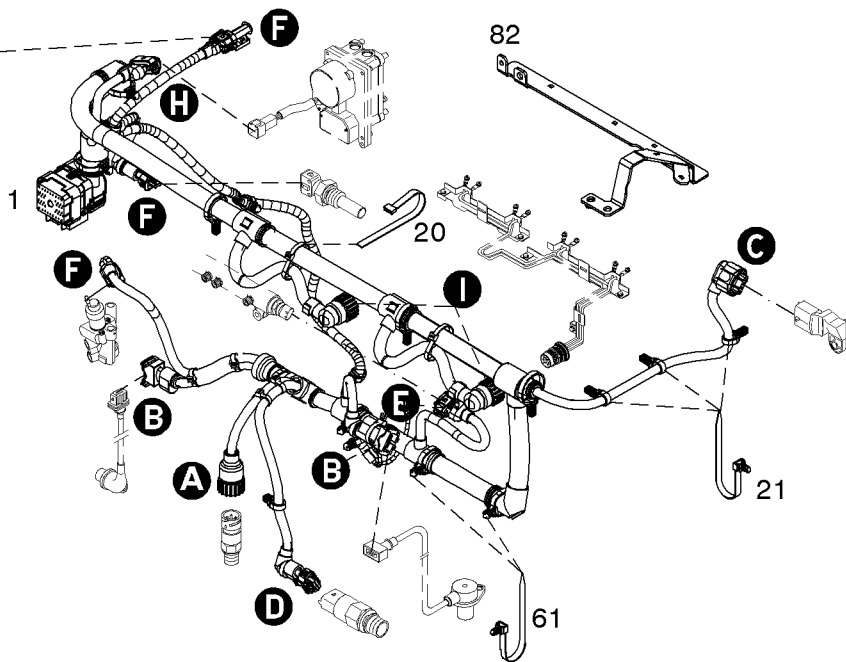



Befestigungsteile
Fastenings
Pieces de fixation
Piezas de sujeción

Referenznr.:

0128-**48**- 0510 2592

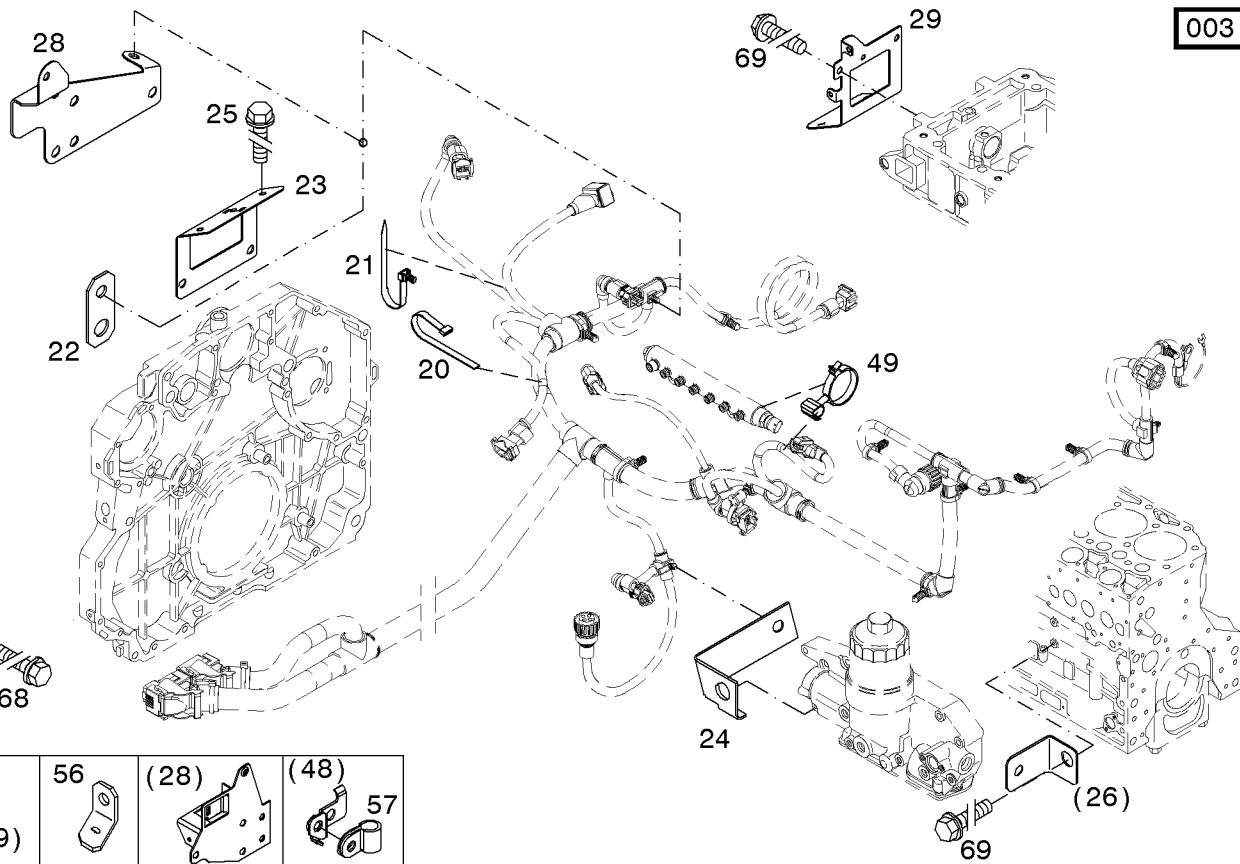
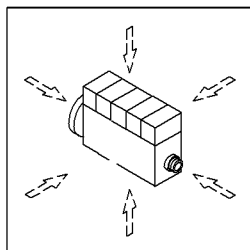

003 ©

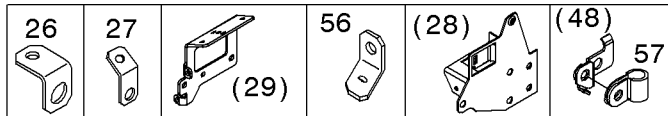



Elektr. Ausrüstung
Electrical equipment
Equipement électrique
Equipo electrico

Referenznr.:

0128-**48**- 0510 2593

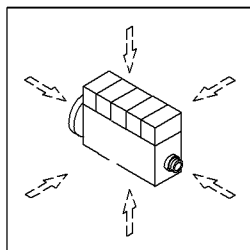

001 ©

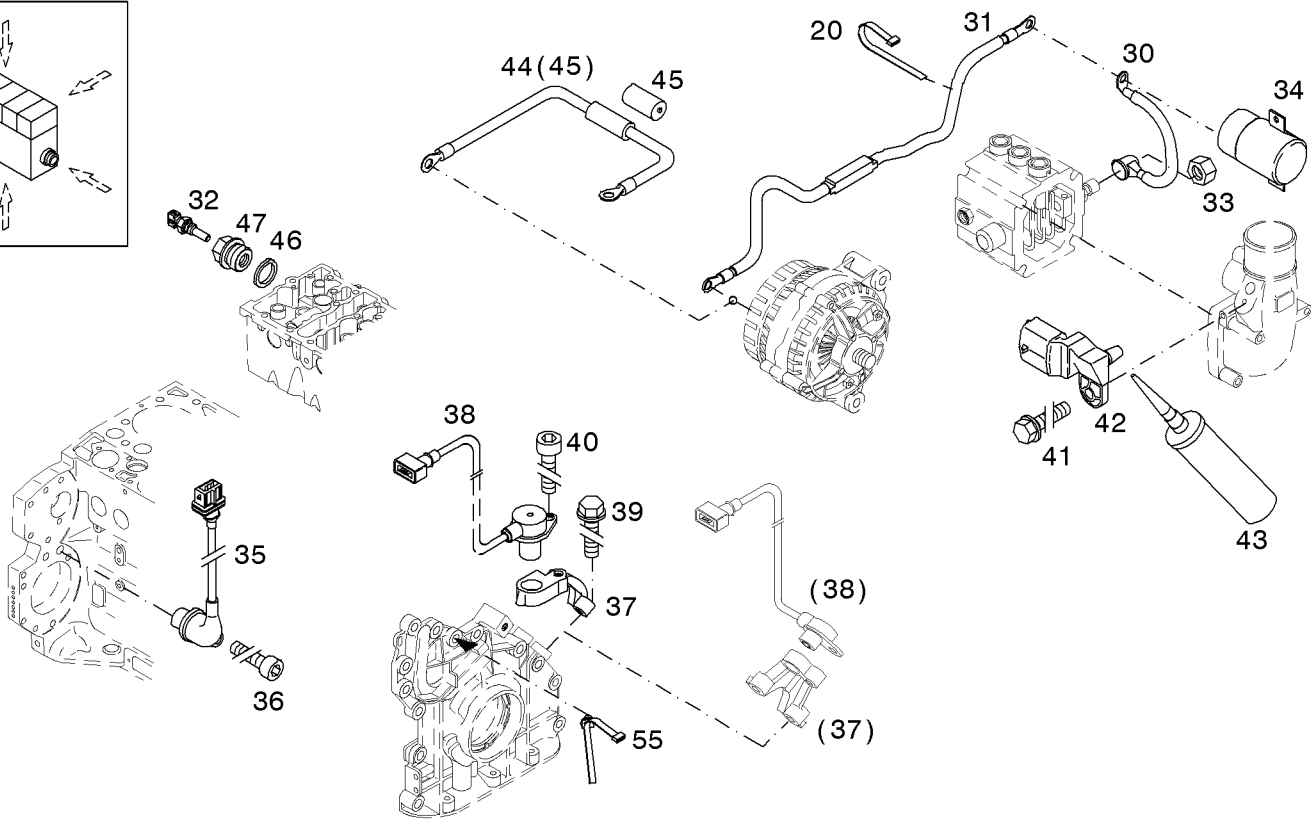



Elektr. Ausrüstung
Electrical equipment
Equipement électrique
Equipo electrico

Referenznr.:

0128-48-0510 2602

003 ©

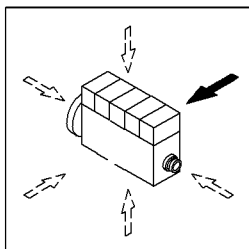

Kundenanschluss
Connection by customer
Connexion client
Conexión per cliente

